

VORTEX SERIES

MASS NOTIFICATION
WARNING PRODUCTS

Our Mass Notification Products Speak for Themselves

WHELEN[®]
MANUFACTURED IN AMERICA



VORTEX SERIES

WHELEN
MANUFACTURED IN AMERICA

OUTDOOR ALL HAZARDS ROTATING WARNING SIREN

Whelen's **VORTEX™** Series All Hazard High Power Sirens provide an **economical alternative** for **powerful siren communication** without compromising quality.

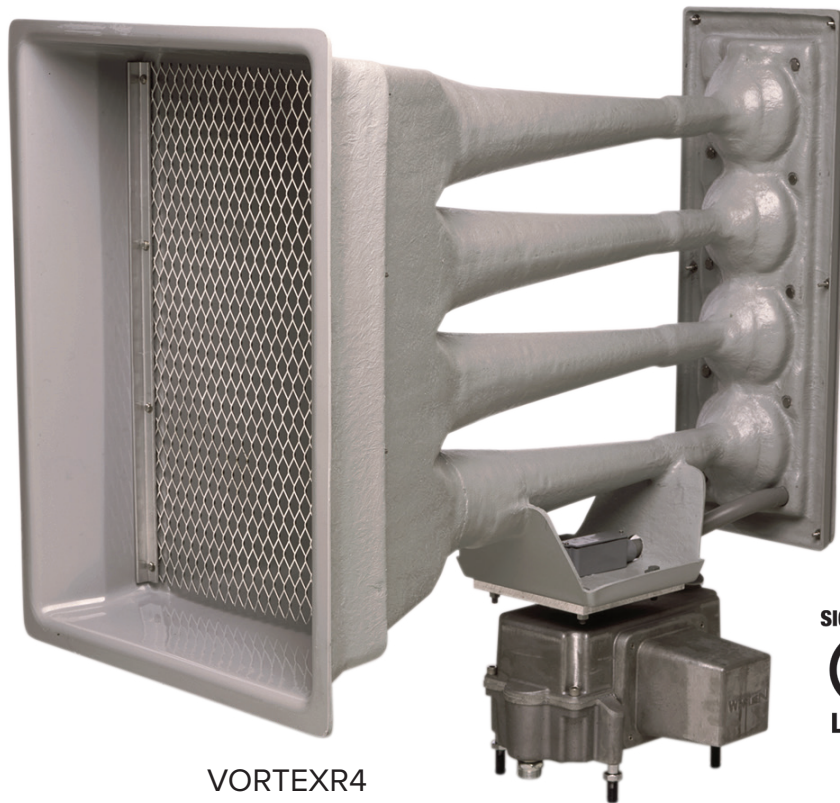

VORTEXR4
Four cell speaker
housing mounted on
rotor





SPECIFICATIONS

SYSTEM FEATURES

- **VORTEXR2 - VORTEXR4** speaker with either two, three, or four active speaker cells depending on selection made.
- Two-compartment (Type I) natural finish aluminum cabinet
- Speaker cell includes either two, three, or four high efficiency 400 watt speaker drivers. Depending on selection made.
- 50' (15.24m) cable included
- Battery powered. Minimum of 15 minutes of full power output with batteries of our recommendation
- AC temperature compensated 5 amp battery charger
- Local or remote controls available
- Two to Four tone-only power amplifiers
- Gear driven rotor
- Electronic siren controller
- Tone Generator Timer
- Local control push-buttons
- Rotor relay control
- **SI TEST**[®]
- Low battery alarm
- Battery tray
- Lightning arrestor
- Six standard warning tones - Wail, Whoop, Alert, Attack, Hi-Lo, Airhorn

SYSTEM OPTIONS

- **Solar option** - 2 each 80 watt panels, with brackets and solar regulator
- **Batteries** - 2 each Whelen approved batteries. Check Whelen's website, www.whelenmassnotification.com, for other recommended batteries
- **Pole top bracket**

ACTIVATION CONTROLS

Our VHF High and UHF siren activation control packages include the following:

- Radio
- Radio interface
- Tone or digital squelch
- 3-5 dB gain omni-directional antenna with bracket
- 35' (10.67 m) of RG58 antenna cable
- Polyphaser
- **SI TEST**

Other features are dependent upon one or two way controls. Whelen equipment can be interfaced with many different types of two-way radio communications products and systems. The following is offered as standard options. Contact factory for special applications.

The following is available as standard options. **BOLD BLACK** indicates the Whelen Model:

ONE-WAY CONTROLS

- **VAUXIN** - Auxilliary board for contact closure activation
- **VD2030LL** - 10 Digit DTMF landline activation
- **VD230NV** - 10 Digit DTMF VHF high-band / 150-170 MHz
- **VD230U** - 10 Digit DTMF UHF / 450-470 MHz

TWO-WAY CONTROLS

- **VAUXCS** - Two-way contact closure activation and status board
- **VC2030LL** - Two-way landline activation
- **VC230NV** - 10 Digit DTMF VHF high-band / 150-170 MHz
- **VC230NU** - 10 Digit DTMF UHF / 450-470 MHz
- **VORTT** - Two tone sequential option

OPTIONS

- **VSTATUS** - Cabinet window LED status indicator
- **VPGINT** - Paging interface to interface Whelen tones with existing paging systems
- **VINTRU** - Intrusion alarm (available with two-way only)

 **WARNING:** This product may contain chemicals known to the State of California to cause cancer and birth defects or other reproductive harm. For more information, visit whelen.com/regulatory.



VORTEX SERIES



SPECIFICATIONS

VORTEX SERIES SPECIFICATIONS

Component	Height Inches (CM)	Width Inches (CM)	Depth Inches (CM)	Weight Lbs. (kg)
VORTEXR2 Speaker & Rotor	49.00 (124.46)	28.50 (72.40)	56.00 (142.24)	190 (86.20)
Electronics Cabinet Type I (Aluminum)	32.50 (82.60)	22.50 (57.20)	10.50 (26.70)	75 (34.10)*
Pole Top Bracket (Optional)	30.50 (77.47) (with top plate)	12.0 (30.50) x 13.50 (34.30)	10.00 (25.40)	71 (32.20)

Component	Height Inches (CM)	Width Inches (CM)	Depth Inches (CM)	Weight Lbs. (kg)
VORTEXR3 Speaker & Rotor	49.00 (124.46)	28.50 (72.40)	56.00 (142.24)	212 (96.20)
Electronics Cabinet Type I (Aluminum)	32.50 (82.60)	22.50 (57.20)	10.50 (26.70)	87 (39.50)*
Pole Top Bracket (Optional)	30.50 (77.47) (with top plate)	12.0 (30.50) x 13.50 (34.30)	10.00 (25.40)	71 (32.20)

Component	Height Inches (CM)	Width Inches (CM)	Depth Inches (CM)	Weight Lbs. (kg)
VORTEXR4 Speaker & Rotor	49.00 (124.46)	28.50 (72.40)	56.00 (142.24)	234 (106.10)
Electronics Cabinet Type I (Aluminum)	32.50 (82.60)	22.50 (57.20)	10.50 (26.70)	87 (39.50)*
Pole Top Bracket (Optional)	30.50 (77.47) (with top plate)	12.0 (30.50) x 13.50 (34.30)	10.00 (25.40)	71 (32.20)

*Less batteries. Two batteries, Delco DC74, add 90 Lbs. (40.90kg). Check with Whelen if a freight quote is needed.



VORTEX SERIES



SPECIFICATIONS

ELECTRICAL

- Battery Charger Input: 120 VAC, 60Hz, 7A fuse
- Battery Charger Output: 28 VDC, 5A (nominal)
- Batteries: (2) 12V, 60 AH lead calcium (user supplied)
- Standby Current: 82mA, 24VDC
- Operating Current: 44A, 66A, 88A, 24VDC
- Power Amplifier Output Power: 800, 1200, 1600 watts,

ACOUSTIC PERFORMANCE

- Wattage: 800, 1200, & 1600 watts
 - Estimated 70dB Range: 4,500 ft / 1372 m, 5,100 ft / 1555 m, & 6,000 ft / 1828m
- Weather, terrain and other structures may impact the range. Each siren within the system may have a decreased or increased range depending on conditions beyond our control

ENVIRONMENTAL

- Operating Temperature: -40°C to +60°C
- Storage Temperature: -65°C to +125°C
- Humidity, Non Condensing: 0 to 95%

ORDERING INFORMATION

Basic system includes the following:

- **VORTEX** - Speaker Assembly & Electronics Cabinet

OPTIONS

- **VAUXIN** - Auxiliary/Status control board for contact closure activation
- **VAUXCS** - Auxiliary/Status control board for contact closure activation and status
- **VD2030LL, VD230NV, VD230NU** - One way radio control ¹
- **VC2030LL, VC230NV, VC2030NU** - Two way radio control/status monitoring, COMM/STAT™¹
- **VORTT** - Two tone sequential
- **VSTATUS** - Cabinet window LED status indicator
- **VPGINT** - Paging interface to interface to Whelen tones with existing paging systems
- **VINTRU** - Intrusion alarm
- **VSBC80** - Solar power ²
- **VPTB** - Speaker pole top bracket
- **BSETVOR**- One pair of batteries

NOTES

¹ 10 digit DTMF controls ● Landline ● VHF High Band / 150-170 MHz ● UHF / 450-470 MHz ● Our VHF High and UHF siren activation control packages include tone squelch, radio, radio interface, 3-5db gain omni-directional antenna with bracket, 35' (10.67m) of RG58 antenna cable and polyphaser

² Solar power option includes 2 - 80 watt panels, mounting bracket and regulator



Type I
Electronic
Cabinet



VORTEX SERIES

WHELEN
MANUFACTURED IN AMERICA

TECH DRAWING

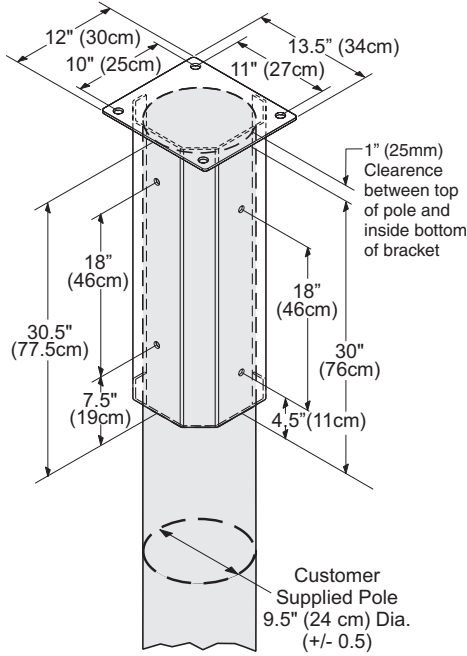

Pole Top Bracket
Mount Dimensions
(Optional Model VPTB)

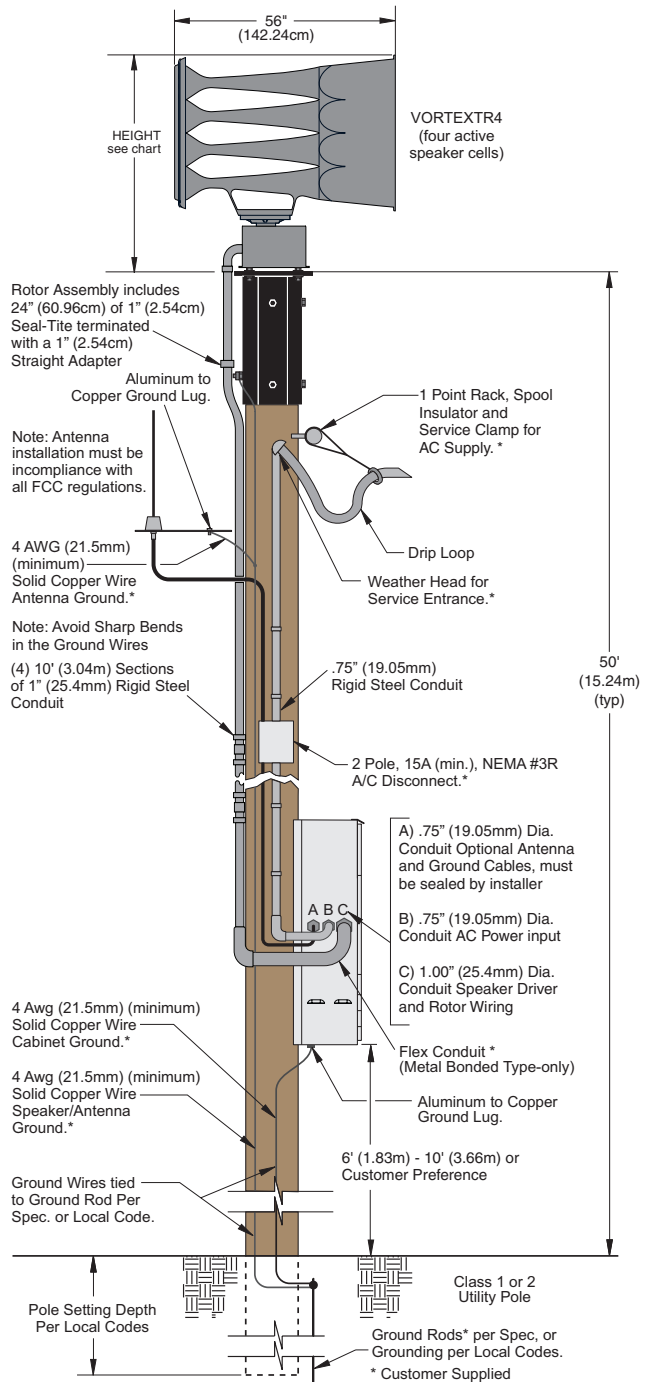

Whelen Engineering Company, Inc.

WARNING: This product may contain chemicals known to the State of California to cause cancer and birth defects or other reproductive harm. For more information, visit whelen.com/regulatory.



VORTEX SERIES

WHELEN
MANUFACTURED IN AMERICA

PRODUCT SUPPORT

"Our Mass Notification Products Speak for Themselves™"

At **Whelen Engineering**, we not only design and manufacture the **best warning products** available, we stand behind every product we make. For a copy of our warranty, email us at iowserv@whelen.com. **Whelen products are pre-assembled, pre-wired and tested at our facility to ensure product quality and reliability.**

If you're interested in the (most reliable, the **most up-to-date warning products** - and the service that comes with it- give us a call. **Find out why Whelen Engineering is "The First Name In Mass Notification."**

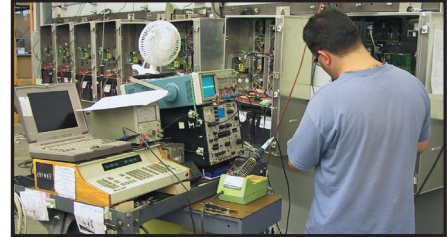

Testing Station

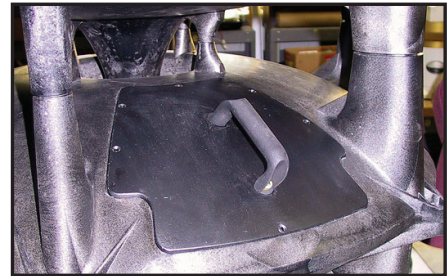

2900 Series Speakers Assembly



SBC280 Solar Power Option



Type II Cabinet Assembly



Type III Cabinet Assembly

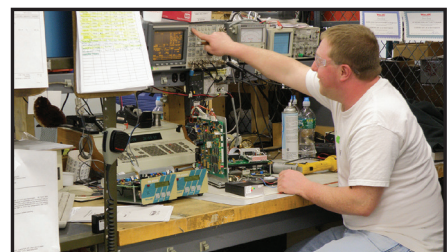

Repair Facility

 **WARNING:** This product may contain chemicals known to the State of California to cause cancer and birth defects or other reproductive harm. For more information, visit whelen.com/regulatory.

VORTEX SERIES

MASS NOTIFICATION
WARNING PRODUCTS

Our Mass Notification Products Speak for Themselves



@WhelenENG

